

# Light Weight Racing Body Type - A (190mm)

CLEAR BODY SHELL  
NO.48072

# killerbody™

1/10 RC PLANNING INSTRUCTION SHEET

This body can be used with 1/10 electronic touring car chassis ( Width: 190mm)

**Before beginning assembly, please read these instructions thoroughly!**

● Symbols used throughout the instruction manual, comprise:



Cut off shaded portion.



5mm  
Drill holes with  
the specified diameter.



Pay close attention here!



Must be purchased  
separately.



Assemble left and right sides  
the same way.



## ● Before Assembly

### Decoration Body

- ▶ In the case of a decoration body, please assemble it according to the contents showed.

### When making the window transparent:

- ▶ If you want to make the window transparent with a non decoration body, please assemble it according to the contents showed.

### Non Decoration Body

- ▶ In the case of non decoration body, please assemble it according to the contents showed.

### When loading LED lights

- ▶ If you want to load LED lights with a non decoration body, please assemble it according to the contents showed.

# 1 Body Shell

When making the window transparent:

Non Decoration Body

When loading LED lights

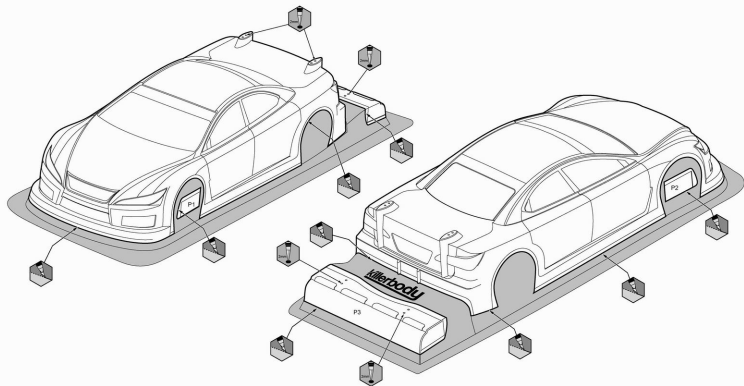

# 2 Painting

- 1 Before painting, use a neutral detergent to remove any oil residues and dirt.

When making the window transparent:

Non Decoration Body

When loading LED lights



When making the window transparent:

When loading LED lights

2 Mask the windows from the inside.

3 Mask the lights from the inside.

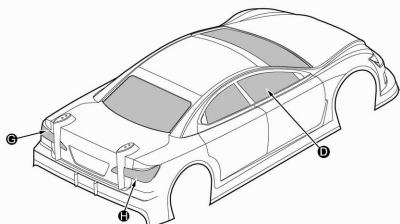
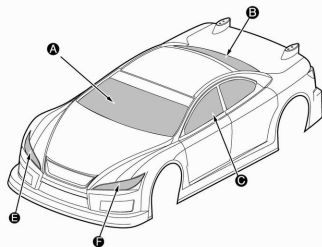
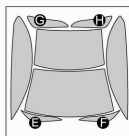
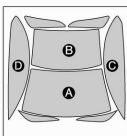

3 Paint the body shell from the inside.

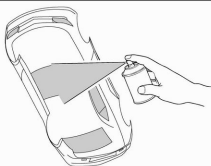

4 After painting, remove the protective body film from the body shell.

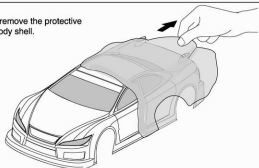

### 3 Decal

When making the window transparent

Non Decoration Body

When loading LED lights

► The decal numbers between brackets are only for the opposite side.

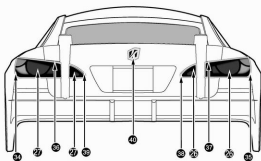
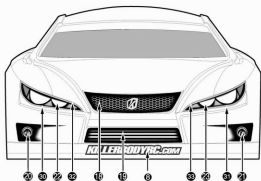

< Decal >

When making the window transparent

When reproducing the light by decal

► Change the decal according to the following contents.

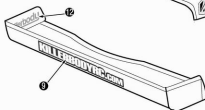
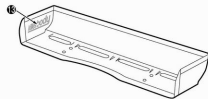
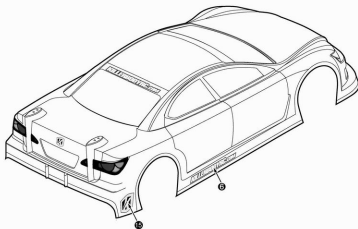
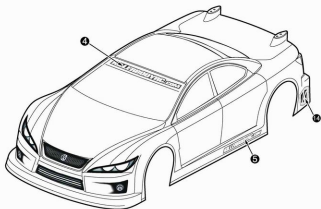

#### 4 Plastic Parts

Decoration Body

Non Decoration Body

When making the window transparent:

When loading LED lights

3X8mm ..... X4

Nut ..... X4

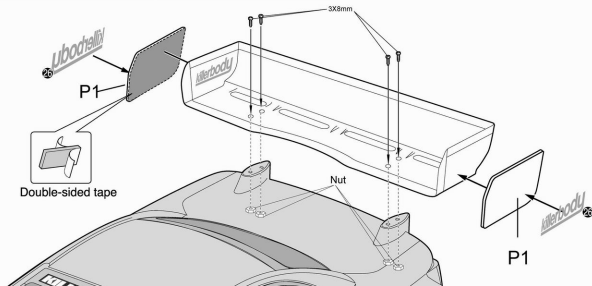

#### 5 Body

Decoration Body

Non Decoration Body

When making the window transparent:

When loading LED lights



For safety reasons, always fit the body shell when running your car.

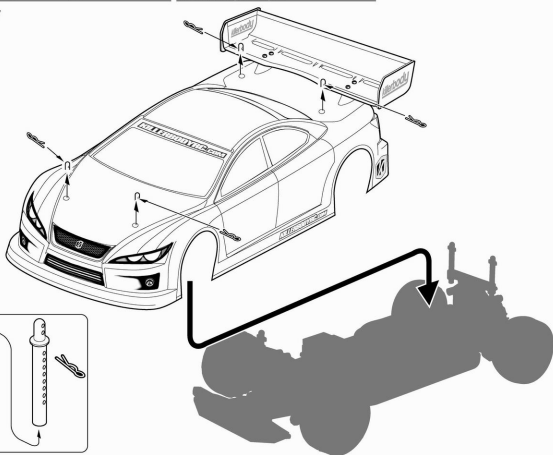

Use the extension body mount (sold separately) if the body mount height is not enough.

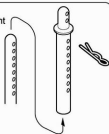

#### Option Parts & Accessory

No.	Part Names	No.	Part Names
48072	Light Weight Racing Body Type - A (190mm) Clear Body		
48074	Light Weight Racing Body Type - A (190mm) Trimmed and Printed in green		
48106	Light Weight Racing Body Type - A (190mm) Trimmed and Printed in fluorescence green		
48107	Light Weight Racing Body Type - A (190mm) Trimmed and Printed in fluorescence orange		
48108	Light Weight Racing Body Type - A (190mm) Trimmed and Printed in light blue		